

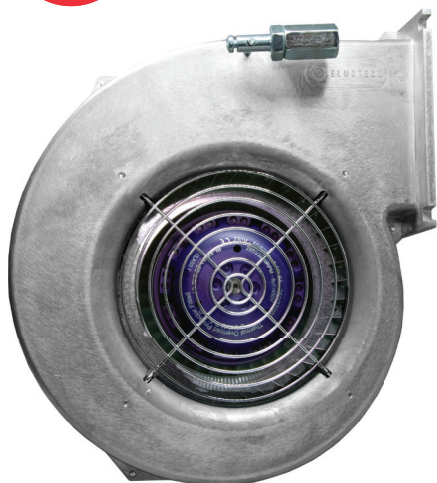

# VFS-160

Forward curved centrifugal blowers in aluminum housing  
 Wheel diameter 160 mm  
 Power supply: 230V 50Hz



**Application:** household and industrial heating systems

**Temperature range:** from -25 to +50 °C

**Material:** Electric motor – AC external rotor motor  
 Housing – die cast aluminum alloy  
 Impeller – galvanized steel

**Insulation class:** «F»

**Bearings:** industrial ball bearings, maintenance-free

**Operation mode:** continuous duty (S1)



Type	Power input, W	Air flow, m³/h	Static pressure, Pa	Speed, min <sup>-1</sup>	Motor capacitor, µF	Weight, kg
VFS-160-2E-A-1	250	591	540	2850	6	3,8

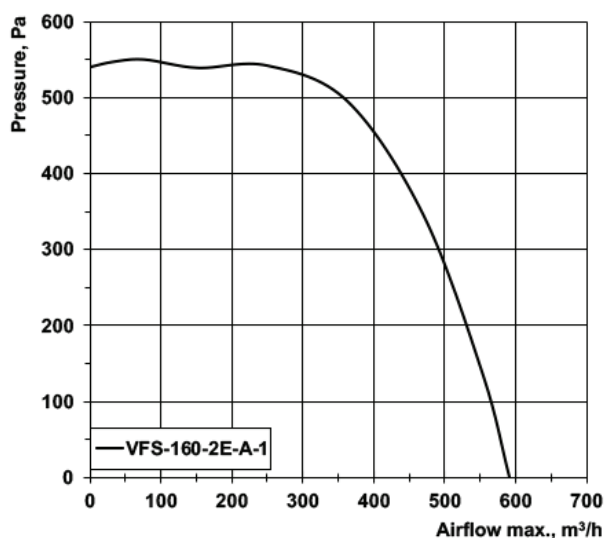
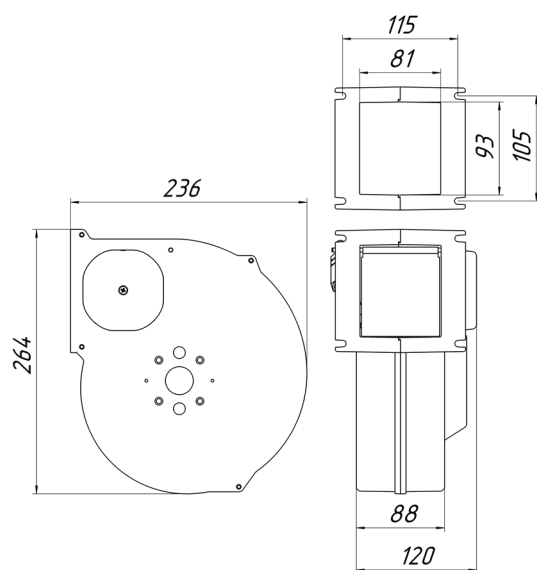

## Additional options

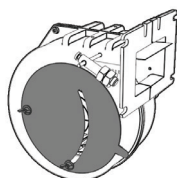

Shutter

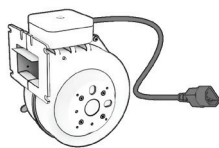

Longer Cable



Black Color Housing

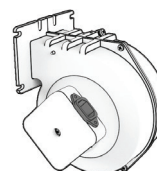

IEC Socket

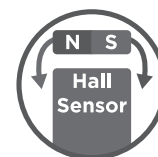

Hall Sensor



# VFS-160

Forward curved centrifugal blowers in aluminum housing  
 Short mounting flange  
 Wheel diameter 160 mm  
 Power supply: 24VDC

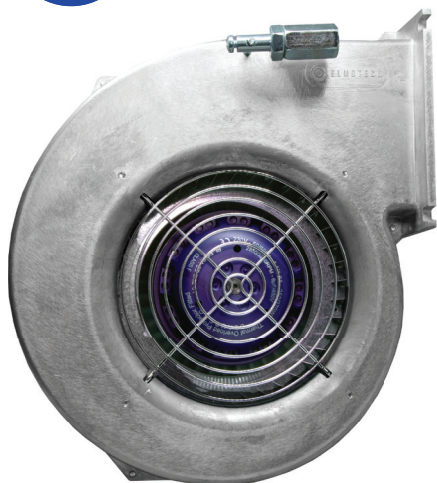

**Application:** household and industrial heating systems

**Temperature range:** from -25 to +50 °C

**Material:** Electric motor – BLDC external rotor motor  
 Housing – die cast aluminum alloy  
 Impeller – galvanized steel

**Insulation class:** «B»

**Bearings:** industrial ball bearings, maintenance-free

**Operation mode:** continuous duty (S1)



Type	Power input, W	Air flow, m³/h	Static pressure, Pa	Speed, min <sup>-1</sup>	Speed Control	Weight, kg
VFS-160-DC-A-1	200	600	550	2900	0-10V	3,8

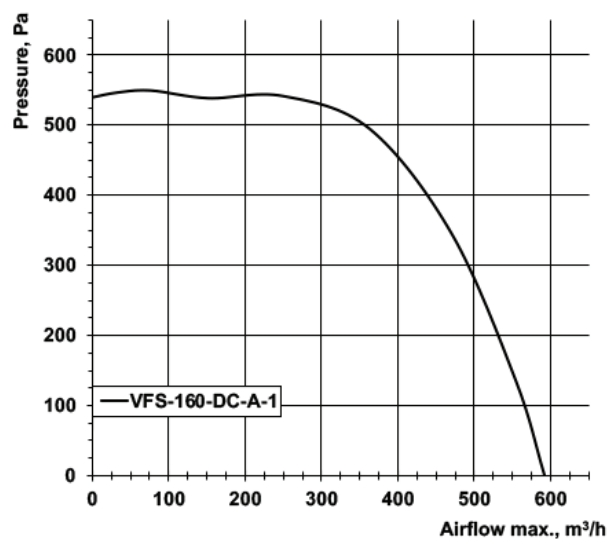
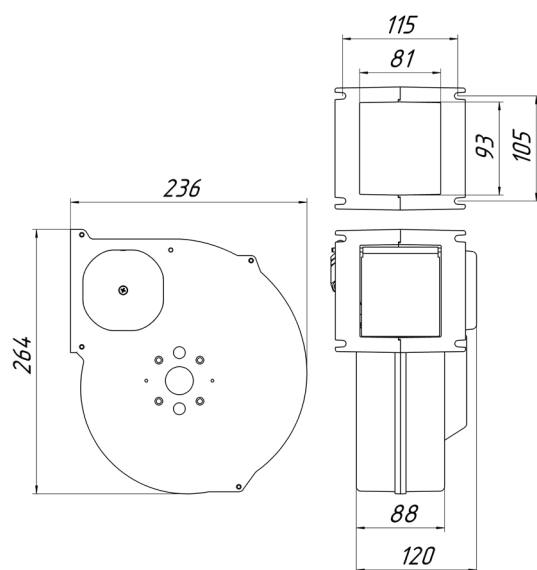

## Additional options

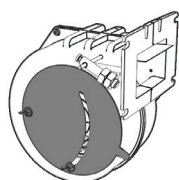

Shutter

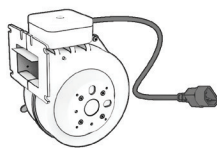

Longer Cable



Black Color Housing

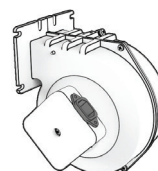

IEC Socket

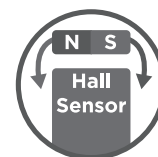

Hall Sensor



# VFS-160

Forward curved centrifugal blowers in aluminum housing  
 Short mounting flange  
 Wheel diameter 160 mm  
 Power supply: 230V 50Hz

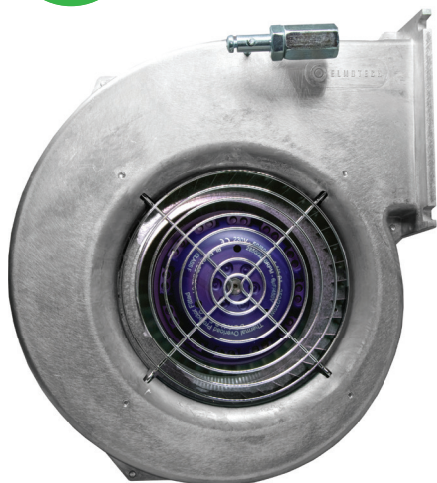

**Application:** household and industrial heating systems

**Temperature range:** from -25 to +50 °C

**Material:** Electric motor – EC external rotor motor  
 Housing – die cast aluminum alloy  
 Impeller – galvanized steel

**Insulation class:** «B»

**Bearings:** industrial ball bearings, maintenance-free

**Operation mode:** continuous duty (S1)



Type	Power input, W	Air flow, m³/h	Static pressure, Pa	Speed, min <sup>-1</sup>	Speed Control	Weight, kg
VFS-160-EC-A-1	200	500	550	2300	0-10V / PWM	3,8

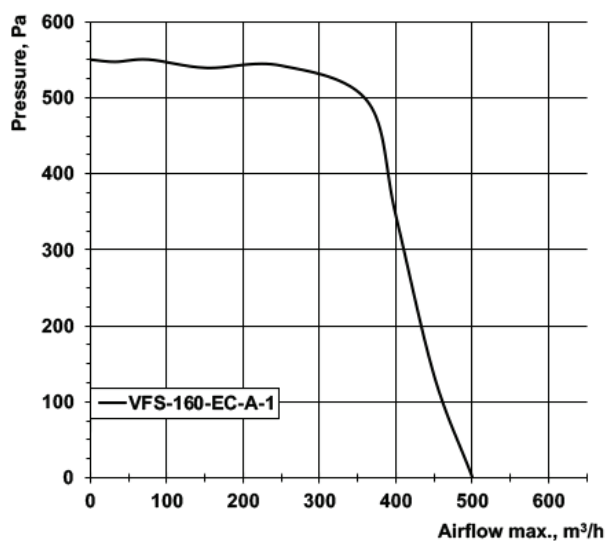
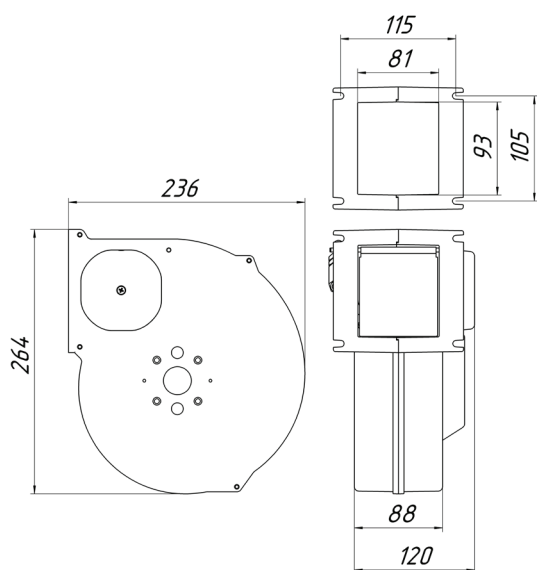

## Additional options

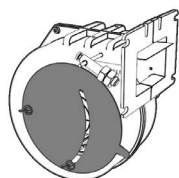

Shutter

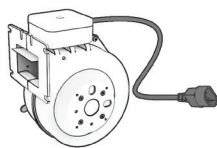

Longer Cable



Black Color Housing

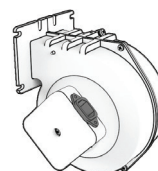

IEC Socket

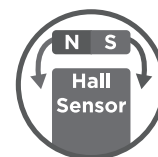

Hall Sensor