



VFS-140

Forward curved centrifugal blowers in aluminum housing
 Wheel diameter 140 mm
 Power supply: 230V 50Hz



Application: household and industrial heating systems

Temperature range: from -25 to +50 °C

Material: Electric motor – EC external rotor motor
 Housing – die cast aluminum alloy
 Impeller – galvanized steel

Insulation class: «B»

Bearings: industrial ball bearings, maintenance-free

Operation mode: continuous duty (S1)



Type	Power input, W	Air flow, m³/h	Static pressure, Pa	Speed, min ⁻¹	Speed Control	Weight, kg
VFS-140-EC-A-1	66	450	210	1700	0-10V / PWM	3

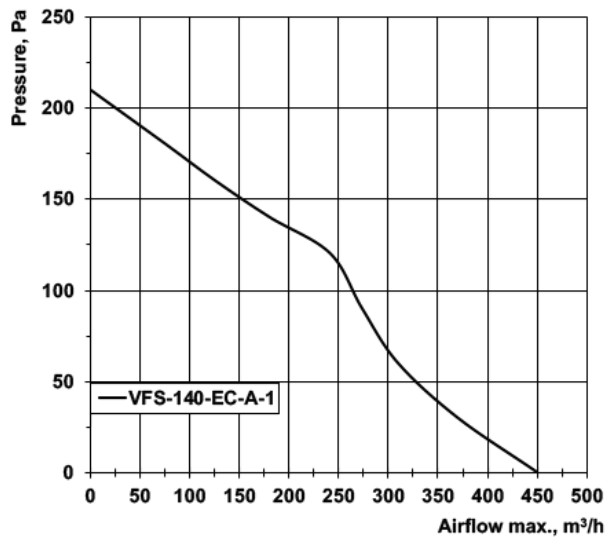
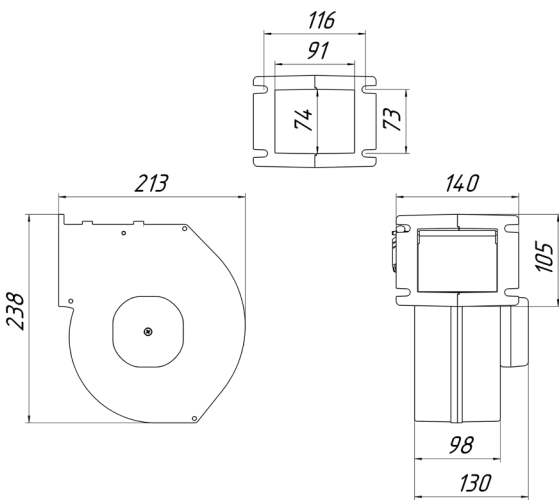

Additional options

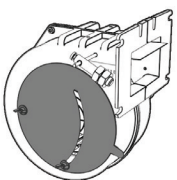

Shutter

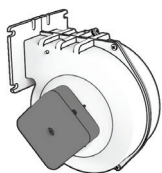

Junction Box on the Side

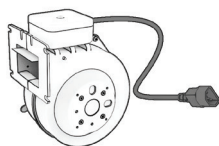

Longer Cable



Black Color Housing

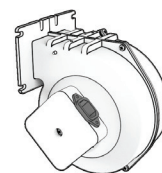

IEC Socket

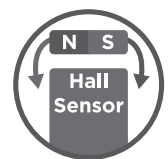

Hall Sensor